

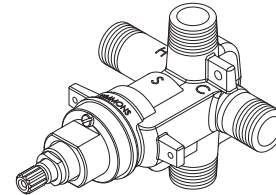

SYMMONS® Temptrol®

Location:



262BODY and 162BODY PRESSURE BALANCING SHOWER & TUB/ SHOWER VALVE BODY SPECIFICATION SUBMITTAL

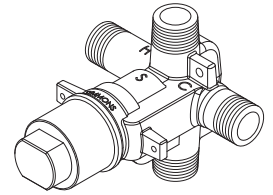

262BODY



162BODY

Model Numbers	Feature Highlights
<input type="checkbox"/> 262BODY Pressure Balancing tub/shower valve body <input type="checkbox"/> 162BODY Pressure Balancing tub/shower valve body with pressure testing cap	<ul style="list-style-type: none"> • Brass, bronze and stainless steel construction • Pressure balancing mixing valve to maintain safe shower temperature • Adjustable stop screw to limit handle rotation • 4 port valve body in common plane • Inlets: 1/2" IPS and 1/2" sweat • Outlets: 1/2" IPS and 1/2" sweat • Accommodates back-to-back installation when using reverse seat • Accommodates thin wall installations • Stringer mounts included
Options/ Modifications	Warranty
<input type="checkbox"/> RV Reverse seat for back-to-back installations <input type="checkbox"/> BR Temptrol Rapid Install™ Bracket <input type="checkbox"/> CP CPVC fittings <input type="checkbox"/> P1 PEX crimp fittings <input type="checkbox"/> P2 PEX expansion fittings <input type="checkbox"/> P3 ProPress fittings Compliance <ul style="list-style-type: none"> • ASME A112.18.1/CSA B125.1 • ASSE 1016 • Buy American Act Compliant  	<p>Limited Lifetime - to the original end purchaser in consumer/residential installations. 10 Years - for commercial/industrial installations. Refer to www.symmons.com/warranty for complete warranty information.</p> 

SKU Builder

Series	Reverse Seat	Rapid Install	Fittings	BODY	Final SKU
262	RV	BR	P1	BODY	262RVBRP1BODY

Architectural/ Engineering Specification

Symmons _____ PRESSURE BALANCING SHOWER & TUB/ SHOWER VALVE BODY. Includes Brass, bronze, and stainless steel construction, pressure balancing mixing valve to maintain safe shower temperature, adjustable stop screw to limit handle rotation, 4 port valve body in common plane, inlets: 1/2" IPS and 1/2" sweat, outlets: 1/2" IPS and 1/2" sweat, accommodates back-to-back installation when using reverse seat, accommodates thin wall installations, stringer mounts included. 10 Year Commercial Warranty. ASME A112.18.1/CSA B125.1, ASSE 1016, and Buy American Act compliant. Available options: "RV - Reverse seat for back-to-back installations", "BR - Temptrol Rapid Install™ Bracket", "CP - CPVC fittings", "P1 - PEX crimp fittings", "P2 - PEX expansion fittings", and "P3 - ProPress fittings".

262BODY & 162BODY

Dimensions

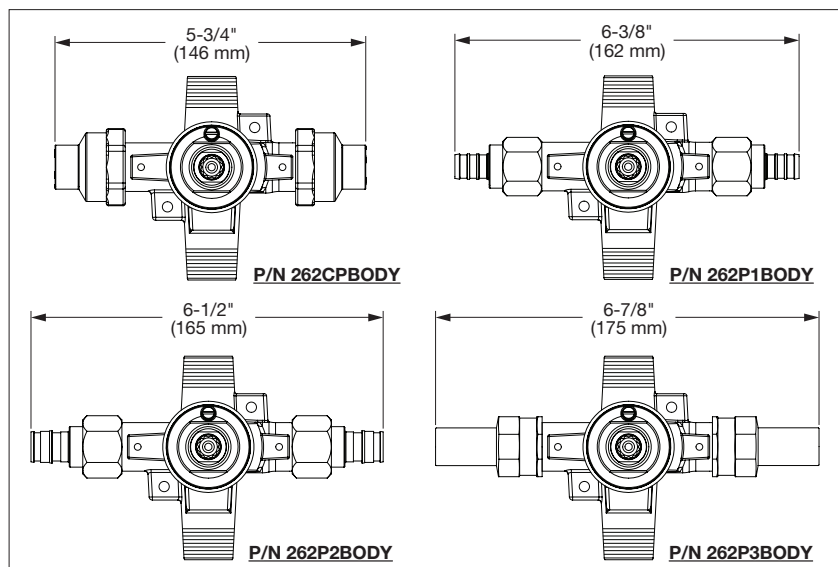
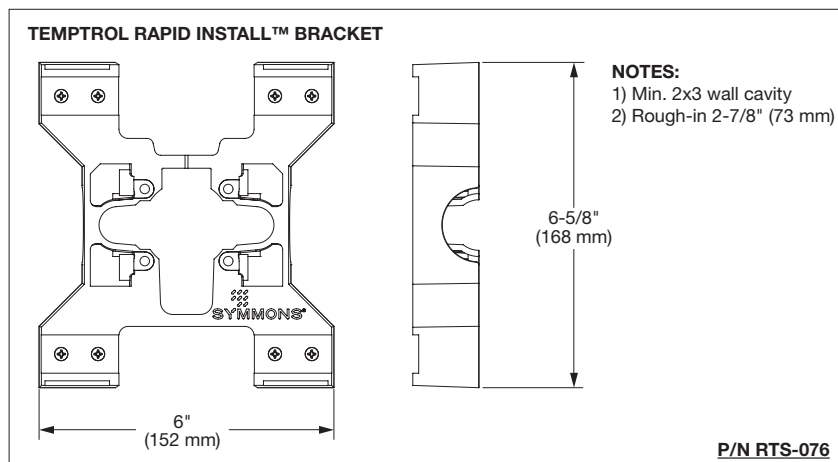
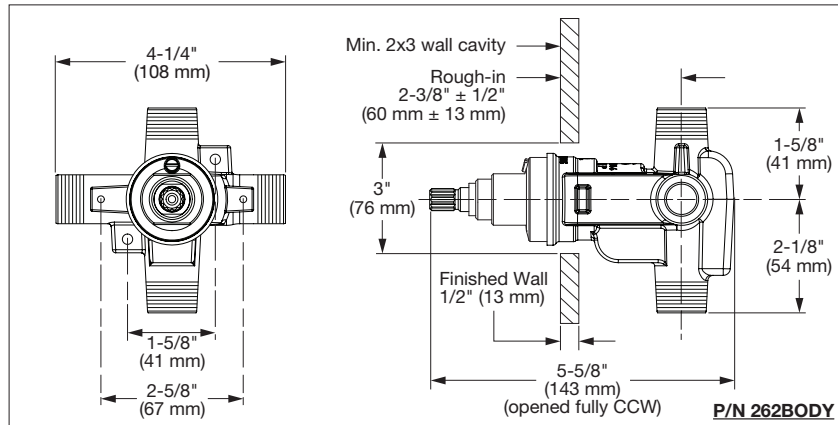



Emplacement:

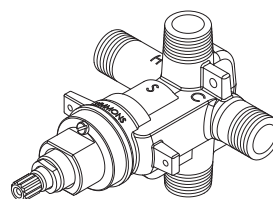

SYMMONS® Temptrol®262BODY et 161BODY
CORPS DE VALVE DE DOUCHE ET DE
BAIGNOIRE/DOUCHE À ÉQUILIBRAGE DE
PRESSION

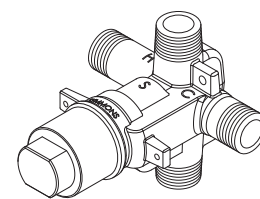
262BODY



162BODY

SOUSSION DES SPÉCIFICATIONS

Numéros de modèle	Feature Highlights
<input type="checkbox"/> 262BODY Corps de valve de baignoire/douche à équilibrage de pression <input type="checkbox"/> 162BODY Corps de valve de baignoire/douche à équilibrage de pression avec bouchon de test de pression	<ul style="list-style-type: none"> • Construction en laiton, bronze et acier inoxydable • Mitigeur à équilibrage de pression pour maintenir une température de douche sûre • Vis d'arrêt réglable pour limiter la rotation de la poignée • Corps de vanne 4 voies dans un plan commun • Entrées : 1/2" IPS et 1/2" sweat • Sorties : 1/2" IPS et 1/2" sweat • Permet une installation dos à dos lors de l'utilisation d'un siège inversé • Convient aux installations à paroi mince • Supports de limon inclus
Choix	
<input type="checkbox"/> RV Siège inversé pour les installations dos à dos <input type="checkbox"/> BR Support Temptrol Rapid Install™ <input type="checkbox"/> CP Raccords en CPVC <input type="checkbox"/> P1 Raccords à sertir PEX <input type="checkbox"/> P2 Raccords expansibles PEX <input type="checkbox"/> P3 Raccords ProPress	Garantie Durée de vie limitée - jusqu'à la fin d' consommateur/acheteur résidentiel installations. 10 ans - pour commercial/industriel installations. Faire référence à www.symmons.com/garantie pour informations complètes sur la garantie
Conformité	
<ul style="list-style-type: none"> • ASME A112.18.1/CSA B125.1 • ASSE 1016 • Buy American Act Compliant  	

Générateur de SKU

Séries	Siège inversé	Installation rapide	Raccords	BODY	SKU finale
262	RV	BR	P1	BODY	262RVBRP1BODY

Spécification architecturale/technique

Symmons _____ CORPS DE VALVE À ÉQUILIBRAGE DE PRESSION POUR LA DOUCHE ET LA BAIGNOIRE/DOUCHE. Comprend une construction en laiton, bronze et acier inoxydable, une vanne mélangeuse à équilibrage de pression pour maintenir une température de douche sûre, une vis d'arrêt réglable pour limiter la rotation de la poignée, un corps de vanne à 4 ports dans un plan commun, des entrées : 1/2" IPS et 1/2" sueur, sorties : 1/2" IPS et 1/2" sweat, s'adapte à une installation dos à dos lors de l'utilisation d'un siège inversé, s'adapte à des installations à parois minces, supports de limon inclus. Garantie commerciale de 10 ans. Conforme aux normes ASME A112.18.1/CSA B125.1, ASSE 1016 et Buy American Act. Options disponibles : "RV - Siège inversé pour installations dos à dos", "BR - Support Temptrol Rapid Install™", "CP - Raccords CPVC", "P1 - Raccords à sertir PEX", "P2 - Raccords d'expansion PEX" et "P3 - Raccords ProPress".

262BODY & 162BODY

Dimensions

