



SLS3522PP  
Single Handle Lavatory Faucet  
**Operation & Maintenance Manual**

**Model Numbers**

**SLS3522PP** *Single Handle Lavatory Faucet with A Push Pop Drain Assembly*

**Feature Highlights**

- Single hole mount configuration
- Quarter turn ceramic cartridge
- 25 inch braided hose water supply connections
- 5" height
- Standard 1.0 gpm (3.8 L/min) flow rate
- Faucet shall be metal construction, plated in standard polished chrome finish

**Compliance**

ASME A112.18.1/CSA B125.1

NSF/ANSI/CAN 61: Q<1, NSF/ANSI 372

WaterSense 1.0 gpm (3.8 L/min)



**⚠ WARNING:** This product can expose you to chemicals including lead, which is known to the state of California to cause cancer, birth defects, or other reproductive harm. For more information, go to [www.P65Warnings.ca.gov](http://www.P65Warnings.ca.gov).

**Warranty**

**Limited Lifetime** - to the original end purchaser in consumer/residential installations.

**10 Years** - for commercial/industrial installations. Refer to [www.symmons.com/warranty](http://www.symmons.com/warranty) for complete warranty information.



**Dimensions**

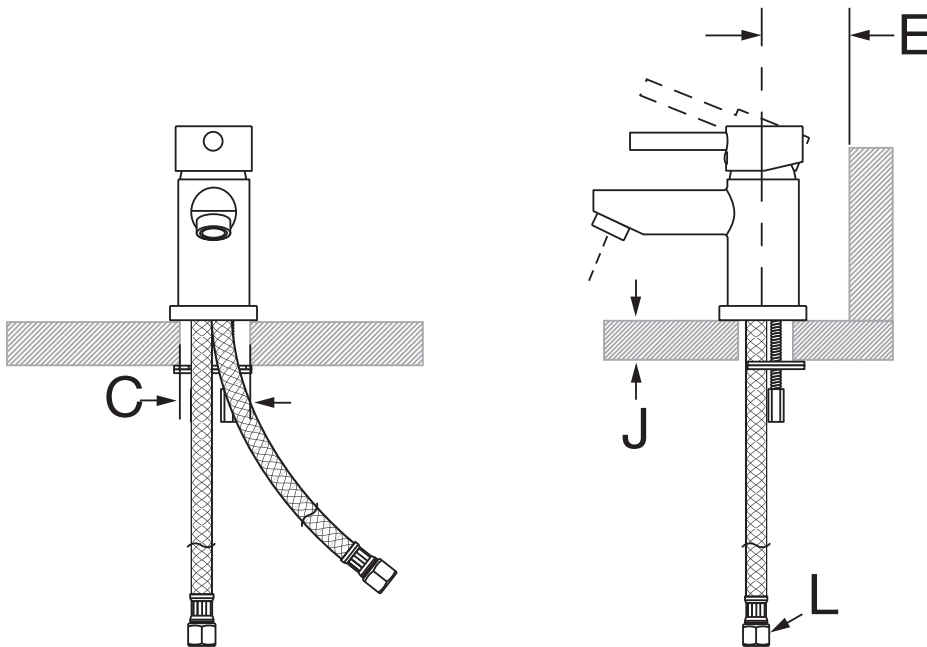





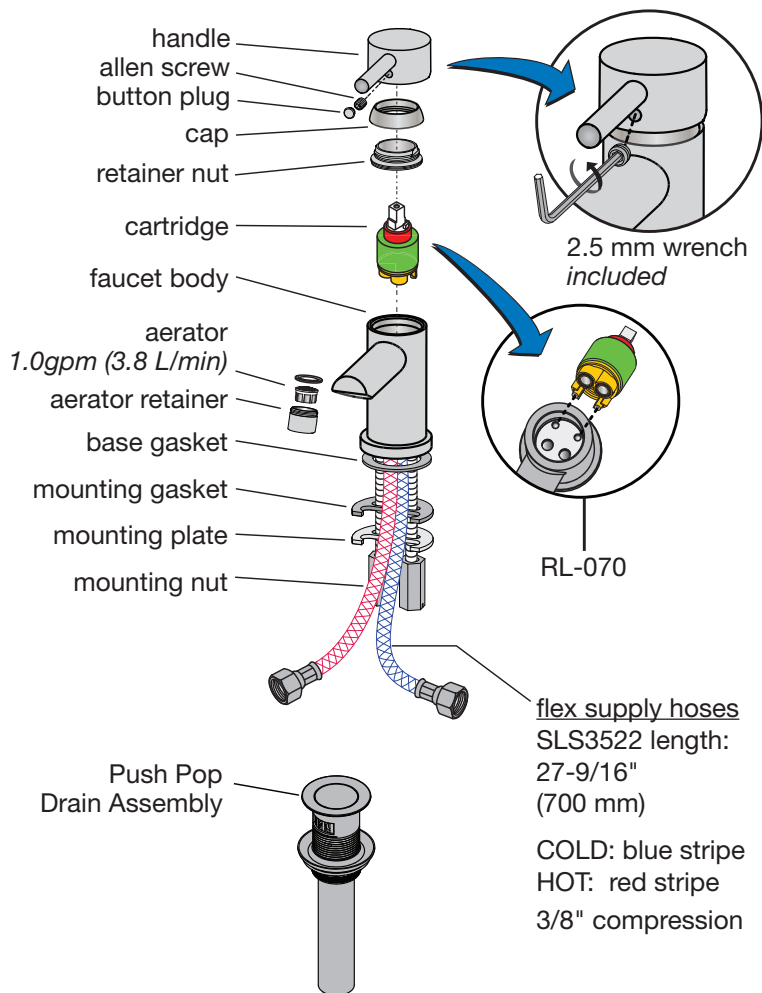

Measurements	
	Hole Size
<b>C</b>	Min. Ø 1-1/4", 32 mm Max. Ø 1-1/2", 38 mm
<b>E</b>	Min. 2-1/2", 64 mm
<b>J</b>	Deck Thickness Ref. Min. 7/8", 22 mm Max. 1-7/8", 47 mm
<b>L</b>	3/8" compression fitting

**Note:** Dimensions subject to change without notice.

## Parts Breakdown







## Replacement Parts

Part Number	Item	
RL-070	Cartridge w/ Limit Stop	
RL-059-1.0* RL-059-0.5*	<b>Aerator kits</b> 1.0 gpm (3.8 L/min) 0.5 gpm (1.9 L/min) <i>includes aerator, retainer &amp; washer</i>	
LN-15-1.0-NA* RL-019*	<b>Non-aerated laminar flow outlet kits</b> 1.0 gpm (3.8 L/min) 0.5 gpm (1.9 L/min) <i>includes aerator, retainer &amp; washer</i>	
RL-066*	<b>Handle kit</b> <i>includes handle, allen screw &amp; RB button plug</i> <i>requires 2.5 mm Allen wrench</i>	
RL-067*	<b>Mounting hardware kit</b> threaded studs (2) hex nut (2) rubber washer (1) metal washer (1)	
LN-01660*	4" deck plate	
RL324*	Push Pop Drain Assembly	

\* Note: For decorative finish faucets append the appropriate suffix code letters to part numbers marked with an asterisk (\*)

## Tools Required

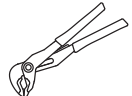
Adjustable Wrench	
Allen wrench (2.5 mm)	
Plumber Putty	
Plumber Tape	
Soft Jaw Pliers	

# Quick Install Guide



**Step 4**  
Flush lines and  
check for leaks

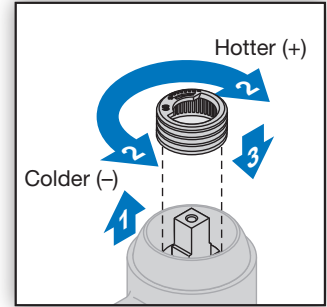

Limit stop adjustment

**Step 2**  
Connect supply hoses

HOT

COLD

**Step 1**  
Attach faucet assembly

**Step 3**  
Push Pop Install: Insert drain body (L) into drain opening. From below, Tighten locking nut (O) with gasket (M) and washer (N) to flange. Tighten tail nut (Y) with washer (X) to secure tail pipe (Q). Do Not overtighten.

Push Pop Drain  
Assembly

