

Location:



SYMMONS® Sereno ActivSense™





S6430B & S6430E

Sensor Lavatory Faucet

Specification Submittal



Includes 4" deck plate

Model Numbers	Feature Highlights
<input type="checkbox"/> S6430B <i>Sensor Lavatory Faucet 6X1.5V Batteries included</i> <input type="checkbox"/> S6430E <i>Sensor Lavatory Faucet 9V Transformer</i>	<ul style="list-style-type: none"> • LEED Rating • Optional hygiene flush • Robust brass body • Adjustable settings • Easy to install • ADA compliant • 4" Deck plate
Finish Options/Modifications	
<input type="checkbox"/> STS <i>Stainless Steel finish</i> <input type="checkbox"/> 035  <i>0.35 gpm (1.3 L/min) flow restrictor</i> <input type="checkbox"/> 10 <i>1.0 gpm (3.8 L/min) flow restrictor</i> Note: Append appropriate suffix to model number.	<ul style="list-style-type: none"> -ASME A112.18.1/CSA B125.1 -NSF/ANSI 372 -UL# E311169 (USA & Canada) -Buy America Act Compliant -ADA Compliant  
Options <i>(sold as separate line items)</i>	Warranty
<input type="checkbox"/> RC6960 <i>Remote Control</i> <input type="checkbox"/> SD6430BL <i>Matching SERENO soap dispenser Battery</i> <input type="checkbox"/> SD6430BF <i>Matching SERENO soap dispenser</i> <input type="checkbox"/> USDP8 <i>8 Inch Deck Plate</i> <input type="checkbox"/> SF259 <i>Converts S6430B to AC powered (S6430E)</i> <input type="checkbox"/> SF278 <i>120V Cable 4.5 feet long Hard wired 15 Amp circuit. (QTY:10) 12 Volt Outputs , 4.2A Any combination of devices 10 devices maximum (SF277 not included)</i> <input type="checkbox"/> 8210CK <i>MaxLine® Tempering Valve</i>	<p>Limited Lifetime - to the original end purchaser in consumer/residential installations.</p> <p>10 Years - for commercial/industrial installations. Refer to www.symmons.com/warranty for complete warranty information.</p> 

Power Layout

1 Device - 1 Power Supply

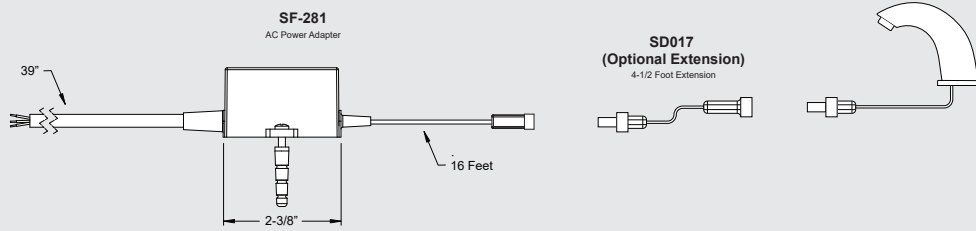

2 Devices - 1 Power Supply

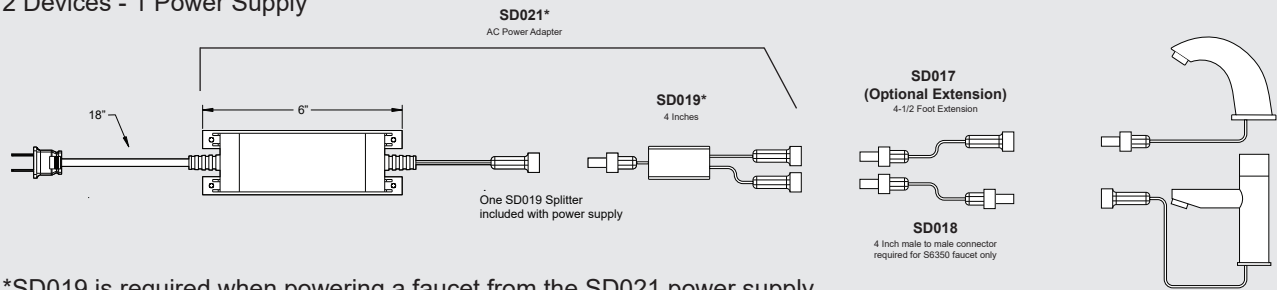

*SD019 is required when powering a faucet from the SD021 power supply.

6 Devices - 2 Power Supply

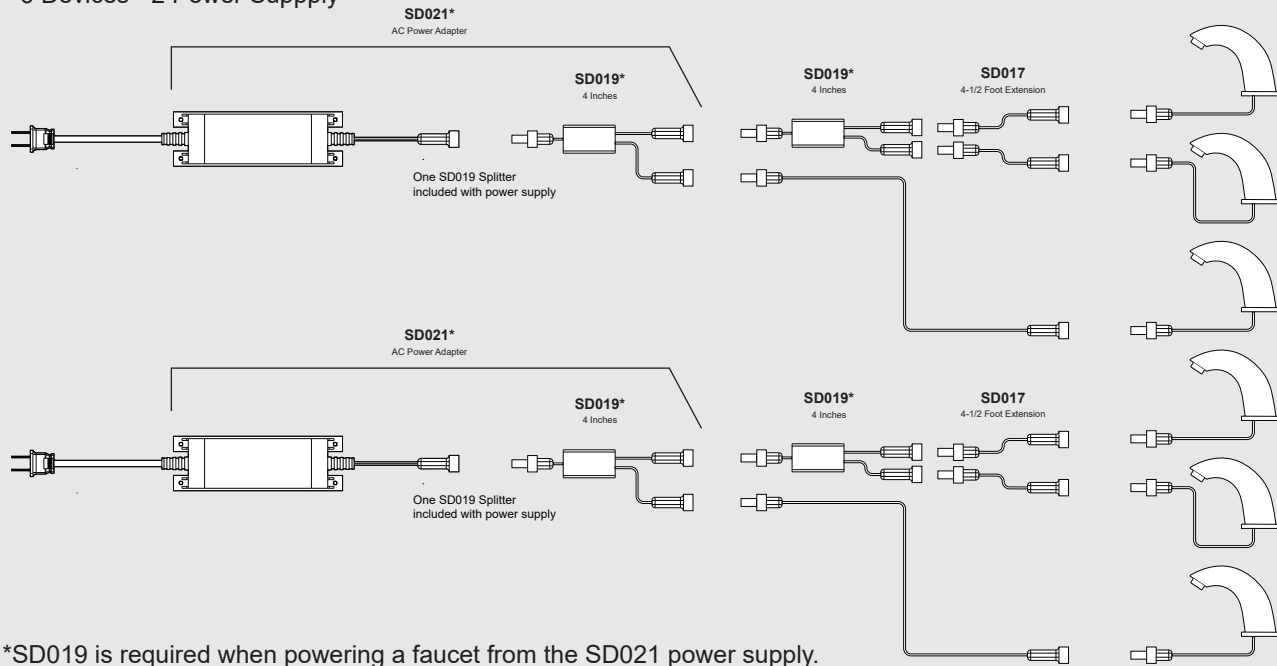

*SD019 is required when powering a faucet from the SD021 power supply.

10 Devices - 1 Power Supply

SF278
 120V Cable 4.5 feet long
 Hard wired 15 Amp circuit.
 (QTY: 10) 12 Volt Outputs: 4.2A
 Any combination of devices
 10 devices maximum
 (SF277 not included)

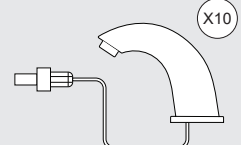
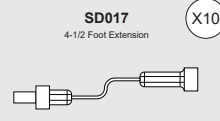
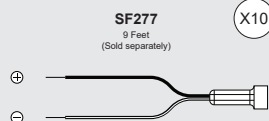
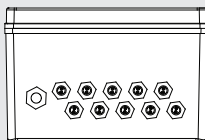

Installation /Repair Parts

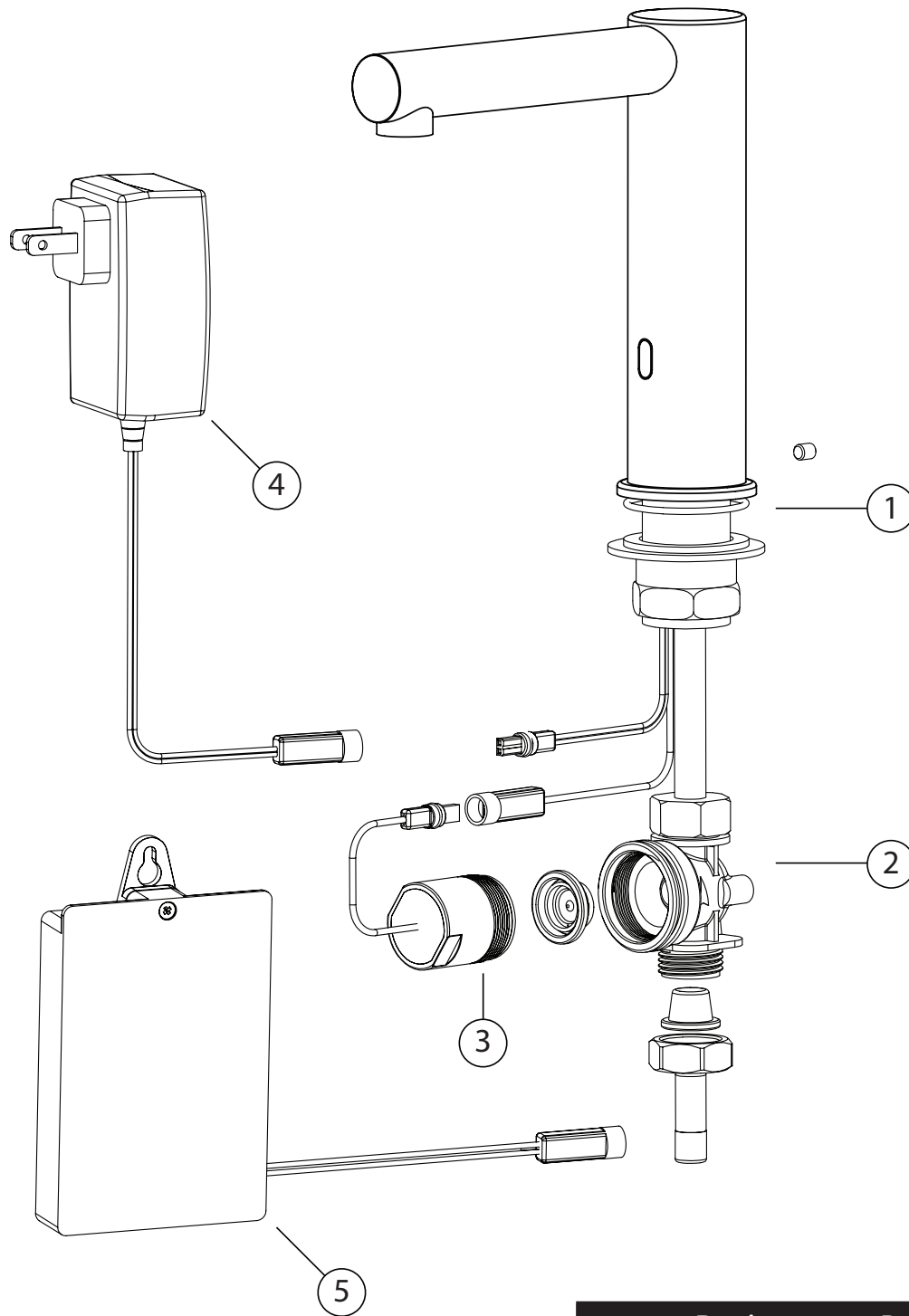

Replacement Parts		
Item	Description	Part No.
1	Seals and screws kit	SF260
2	Solenoid valve kit	SF253
3	Solenoid housing kit	SF255
4	Battery box	SF258
5	9V Transformer	SF259
6	4" Deck plate	USDP4

Note: Dimensions subject to change without notice.

Dimensions

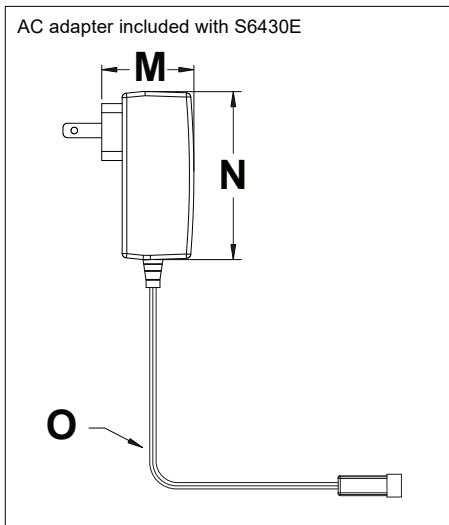
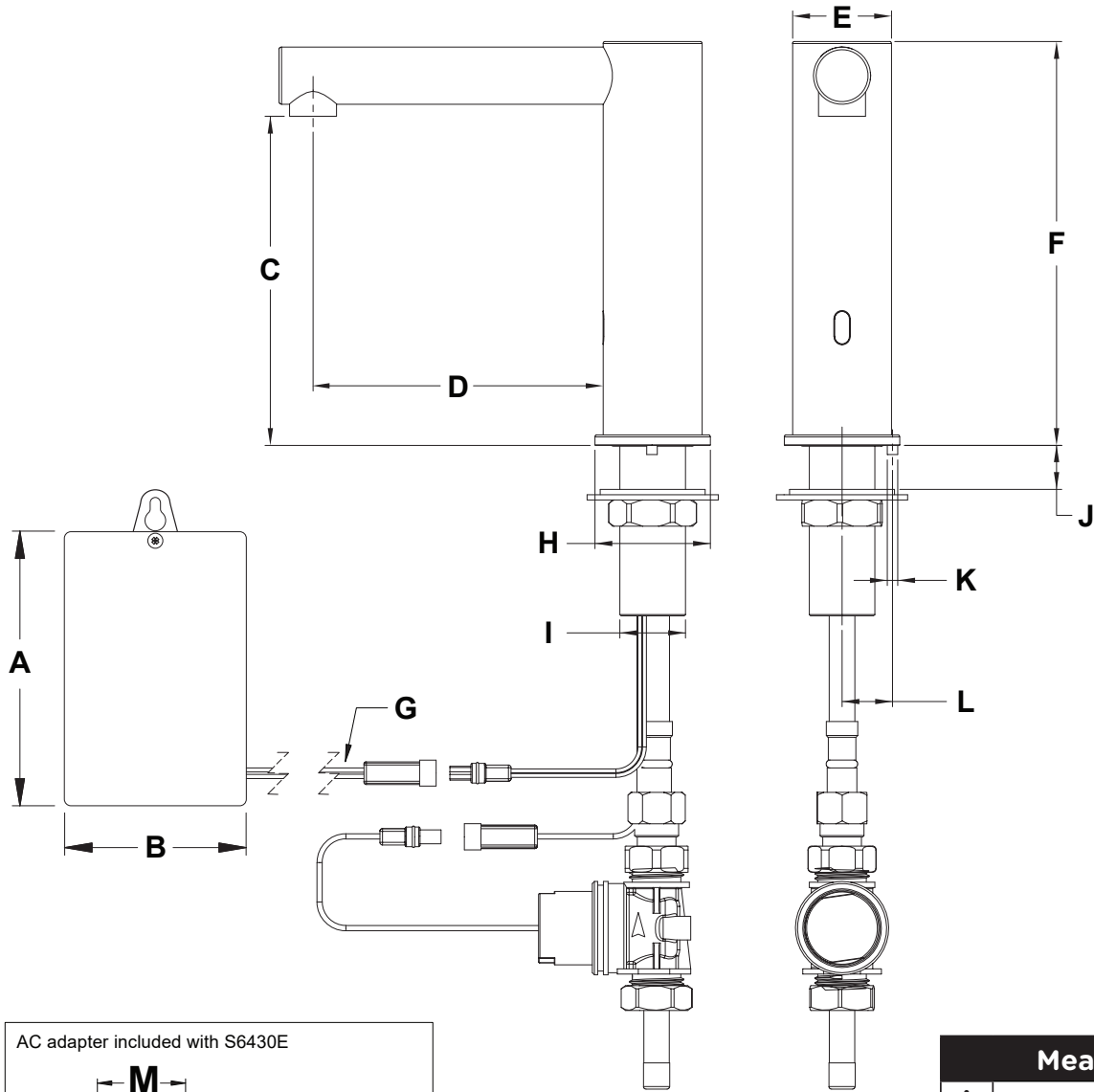

Measurements	
A	5" , 127 mm
B	3" , 76 mm
C	5" , 126 mm
D	4-3/8" , 111 mm
E	Ø 1-1/2" , 38 mm
F	6-1/8" , 154 mm
G	18" , 457 mm
H	Ø Min:1-1/8" , 28 mm Ø Max:1-1/2" , 38 mm
I	Ø 1" , 25 mm
J	Deck Thickness: Max: 2" , 52 mm
K	1/8" , 4 mm
L	3/4" , 19 mm
M	1-5/8" , 41 mm
N	2-7/8" , 74 mm
O	15' , 4.5 m

Note: Dimensions subject to change without notice.